

INSTALLATION GUIDE **X5**

POCKET SLIDING DOOR

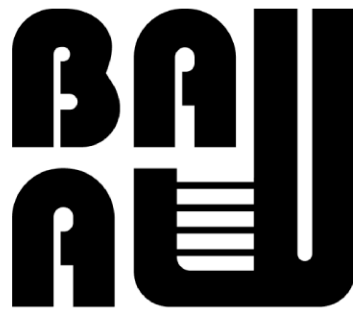

UNIVERSAL SYSTEMS **FOR FRAMELESS DOORS**



BOX CONTENT **X5 POCKET**

P04



DIMENSIONS **X5 POCKET**

P07



INSTALLATION **X5 POCKET**

P10



BOX CONTENT **X5 WALL**

P20



DIMENSIONS **X5 WALL**

P21



INSTALLATION **X5 WALL**

P22

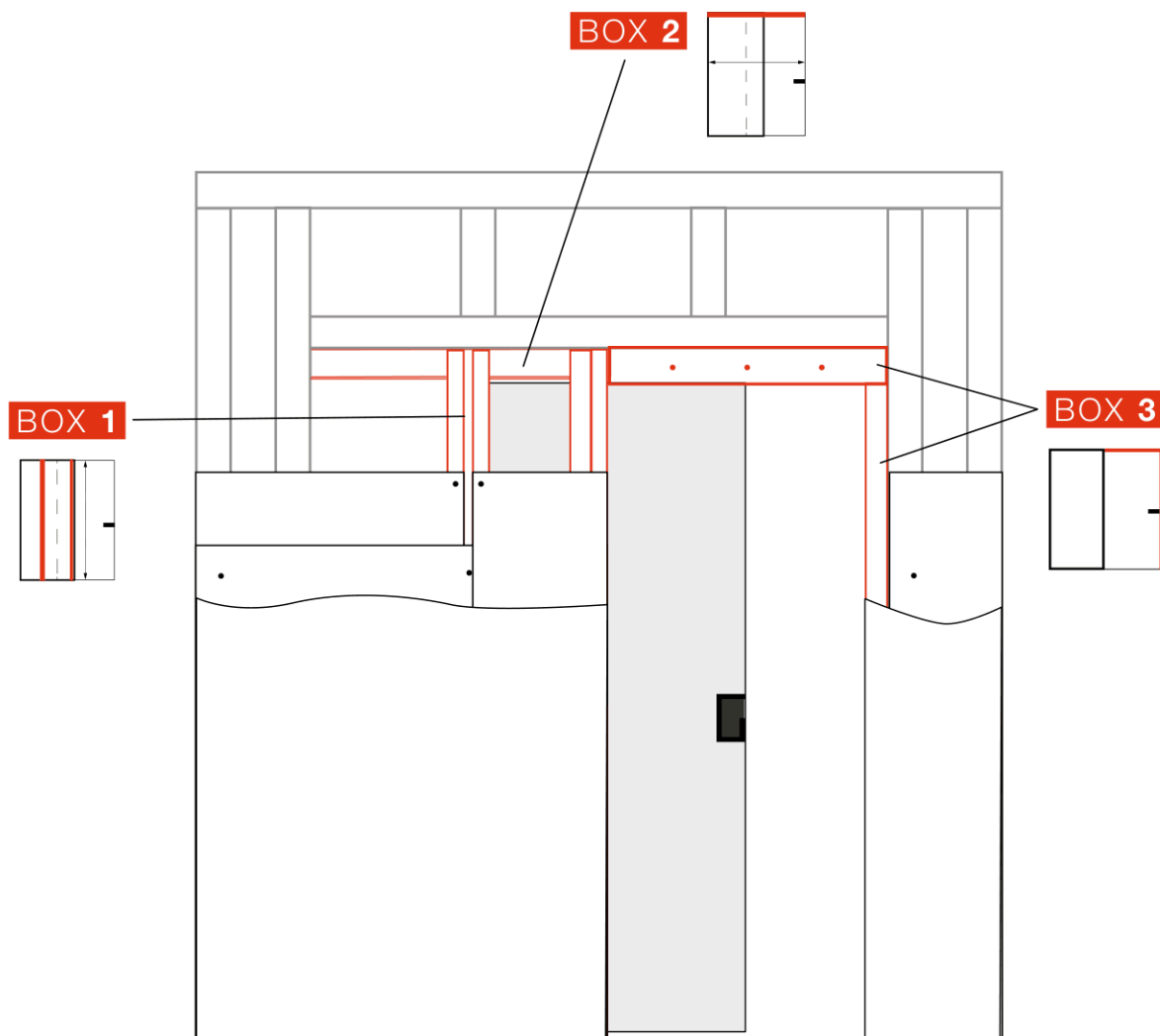



BOXCONTENT POCKET

BOX 1 POCKET

Standers/ montants/ uprights/ Pfosten

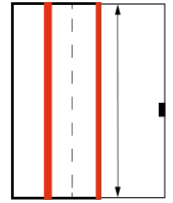

X5

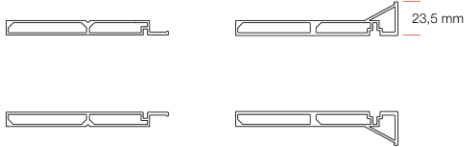

X5-1972

X5-2115

X5-2015

X5-2315

X5-2040

X5D

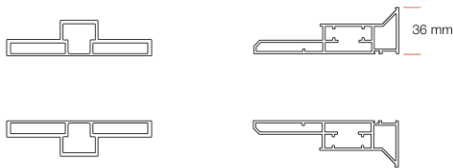

X5D-1972

X5D-2115

X5D-2715

X5D-2015

X5D-2315

X5D-3015

X5D-2040

X5D-2415

X5D32

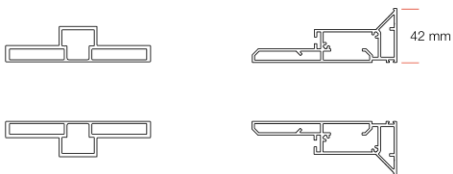

X5D32-1972

X5D32-2115

X5D32-2715

X5D32-2015

X5D32-2315

X5D32-3015

X5D32-2040

X5D32-2415

X5D32-3515

X5D50

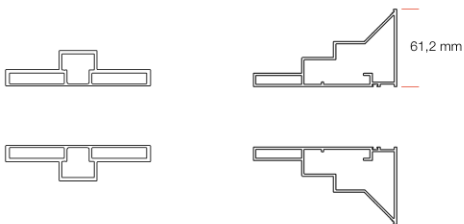

X5D50-1972

X5D50-2115

X5D50-2715

X5D50-2015

X5D50-2315

X5D50-3015

X5D50-2040

X5D50-2415

X5D50-3515

CODE	X5	X5D	X5D32	X5D50	BAUALU Hp*	Pure Hp*	Glass Hp*
...-1972	x	x	x	x	1972 mm	1992 mm	1987 mm
...-2015	x	x	x	x	2015 mm	2035 mm	2030 mm
...-2040	x	x	x	x	2040 mm	2060 mm	2055 mm
...-2115	x	x	x	x	2115 mm	2135 mm	2130 mm
...-2315	x	x	x	x	2315 mm	2335 mm	2330 mm
...-2415		x	x	x	2415 mm	2435 mm	2430 mm
...-2715		x	x	x	2715 mm	2735 mm	2730 mm
...-3015		x	x	x	3015 mm	3035 mm	3030 mm
...-3515			x	x	3515 mm	3535 mm	3530 mm



Dubbele schuifdeur 2x BOX 1
Porte coulissante double 2x BOX 1
Double sliding door 2x BOX 1
Doppel-Schiebetür 2x BOX 1

*Hp: Hoogte deurblad
Hauteur panneau de porte
Height door panel
Höhe Türblatt



BOX 2 DOOR WIDTH

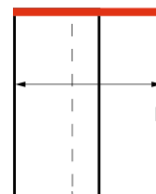

T_p^* 25-60 mm

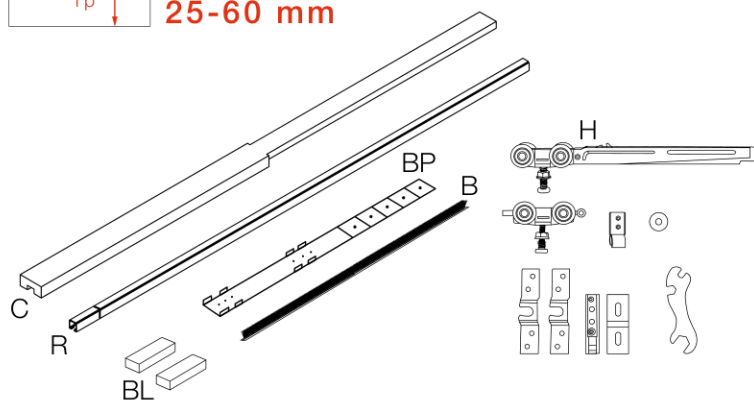

- C = Draagbalk/ traverse/ beam/ Träger
- R = Rail/ Schiene
- BP = Bodemplaot/ plaque de base/
baseplate/ Bodenplatte
- B = Borstels/ brosses/ brushes/ Bürsten
 Ω 75 = 5 mm
 Ω 100 = 19 mm
- BL = Montageblokken/ blocs de styromousse/
styrofoam blocks/ Styropor Blöcke
- H = Beslag/ garniture/ hardware/ Beschläge

T DIN 7981 3,5 x 20 mm (staanders/ montants/ uprights/ Pfosten)
DIN 7504 3,5 x 19 mm (gipskarton/ carton-plâtre/ plasterboard/ gipskartonplatten)

 Dubbele schuifdeur 2x BOX 2
Porte coulissante double 2x BOX 2
Double sliding door 2x BOX 2
Doppel-Schiebetür 2x BOX 2

Door thickness T_p^* :25-40 mm	Door thickness T_p^* :40-60 mm
MS 75	MS100
X5-0830B.75	X5-0830B.100
X5-0930B.75	X5-0930B.100
X5-1030B.75	X5-1030B.100
X5-1230B.75	X5-1230B.100
X5-1530B.75	X5-1530B.100
X5-2030B.75	X5-2030B.100
	X5-2430B.100
	X5-3030B.100

T_p^* 8-12 mm

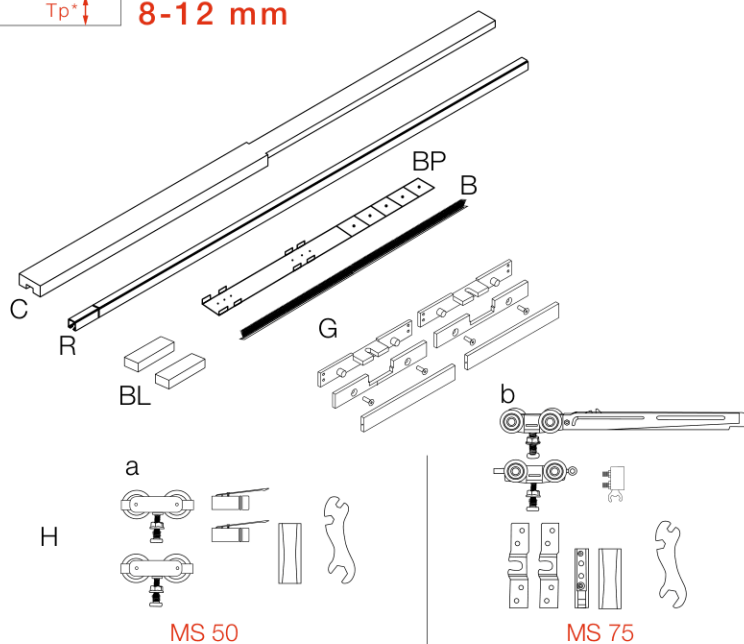

- C = Draagbalk/ traverse/ beam/ Träger
- R = Rail/ Schiene
- BP = Bodemplaot/ plaque de base/
baseplate/ Bodenplatte
- B = Borstels/ brosses/ brushes/ Bürsten
 Ω 50 = 9 mm
 Ω 75 = 19 mm
- BL = Montageblokken/ blocs de styromousse/
styrofoam blocks/ Styropor Blöcke
- H = Beslag/ garniture/ hardware/ Beschläge
a = MS50 b = MS75
- G = Glasklem/ pince à verre/ glass clamps/
Glasklemme

T DIN 7981 3,5 x 20 mm (staanders/ montants/ uprights/ Pfosten)
DIN 7504 3,5 x 19 mm (gipskarton/ carton-plâtre/ plasterboard/ gipskartonplatten)

 Dubbele schuifdeur 2x BOX 2
Porte coulissante double 2x BOX 2
Double sliding door 2x BOX 2
Doppel-Schiebetür 2x BOX 2

MS 50	MS75
X5-0830B.50GLC	X5-0830B.75GLC
X5-0930B.50GLC	X5-0930B.75GLC
X5-1030B.50GLC	X5-1030B.75GLC
	X5-1230B.75GLC
	X5-1530B.75GLC

* T_p : Dikte deurblad
Épaisseur de porte
Door thickness
Türstärke



BOX 3 FINISH

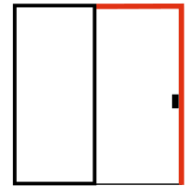

BAUALU

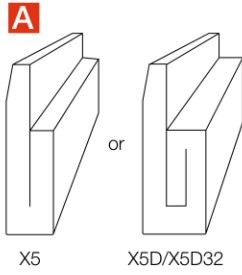

A = Afwerkingsprofielen
 Profils de finition
 Finishing profiles
 Fertigstellungsprofile

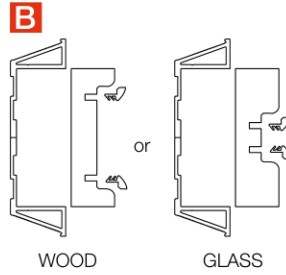

B = Slaglat
 Listel
 Closing profile
 Abschlussprofil

PURE

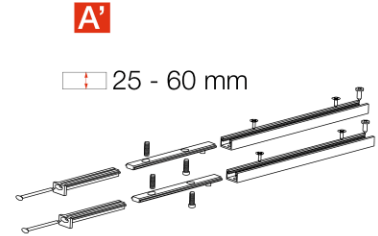

A' = Pure ophanging
 Suspension Pure
 Pure suspension
 Set Pure

BAUALU SINGLE DOOR

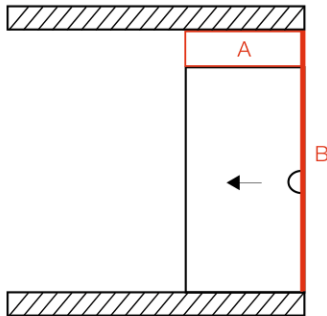

A+B

PURE SINGLE DOOR

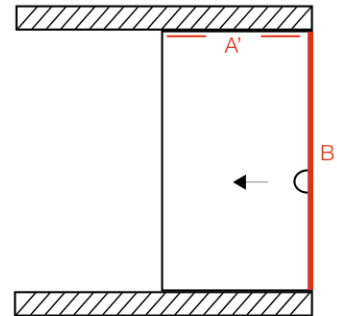

A'+B

BAUALU DOUBLE DOOR

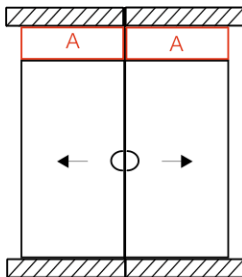

A

PURE DOUBLE DOOR

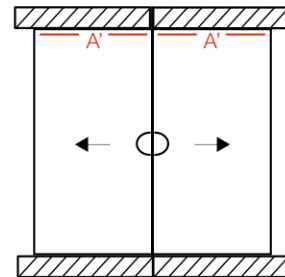

A'



X5 DIMENSIONS POCKET

HEIGHT POCKET WOOD

Hw: Hoogte profielconstructie
Hauteur de la construction
Height profile construction
Konstruktion Profilhöhe

Hp: Hoogte deurblad
Hauteur panneau de porte
Height door panel
Höhe Türblatt

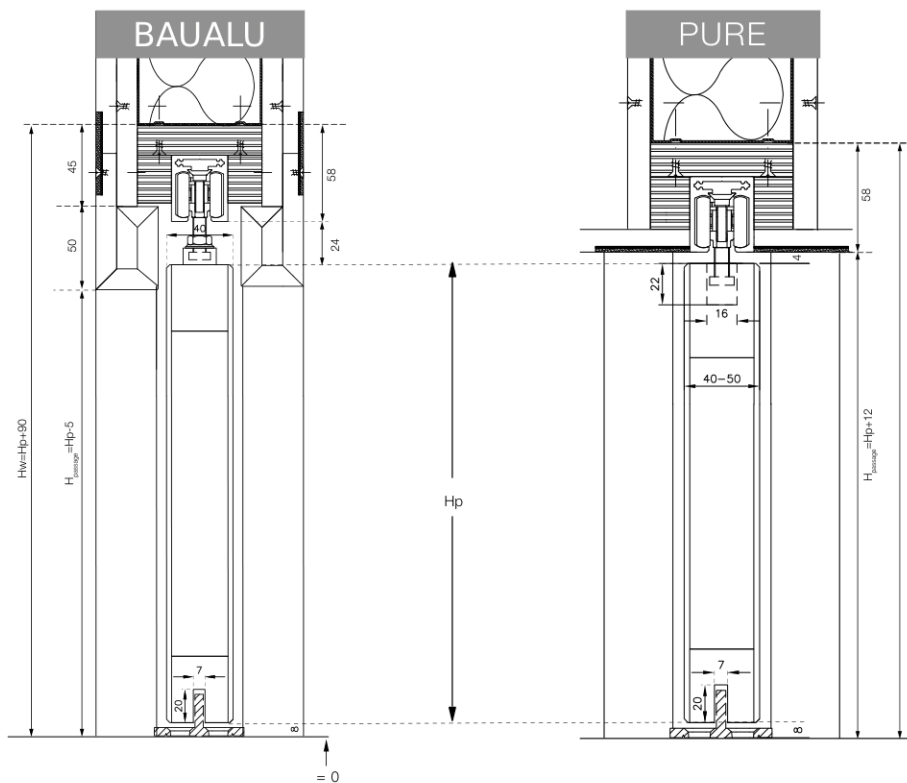

HEIGHT POCKET GLASS

Hw: Hoogte profielconstructie
Hauteur de la construction
Height profile construction
Konstruktion Profilhöhe

Hp: Hoogte deurblad
Hauteur panneau de porte
Height door panel
Höhe Türblatt

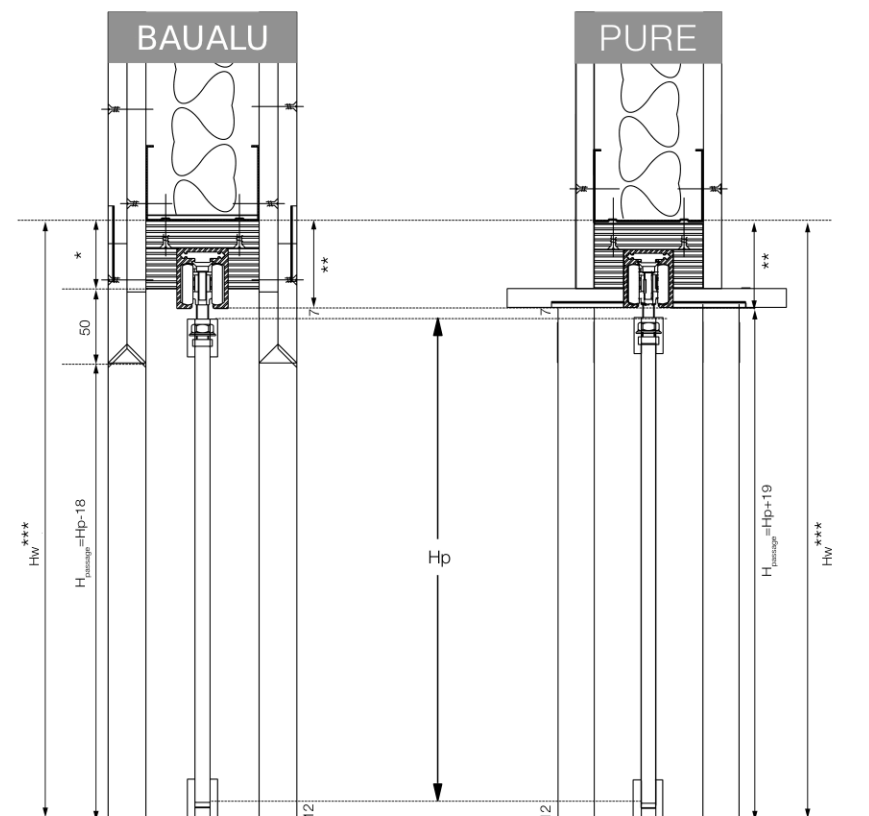

*
MS 50
43 mm

MS 75
45 mm

**
MS 50
56 mm

MS 75
58 mm

***Hw pocket glass
MS 50
Hw=Hp+75 mm

MS 75
Hw=Hp+77 mm



WIDTH SINGLE DOOR

X5 enkele beplating/ simple placage/ single plating/ Einfach beplankung

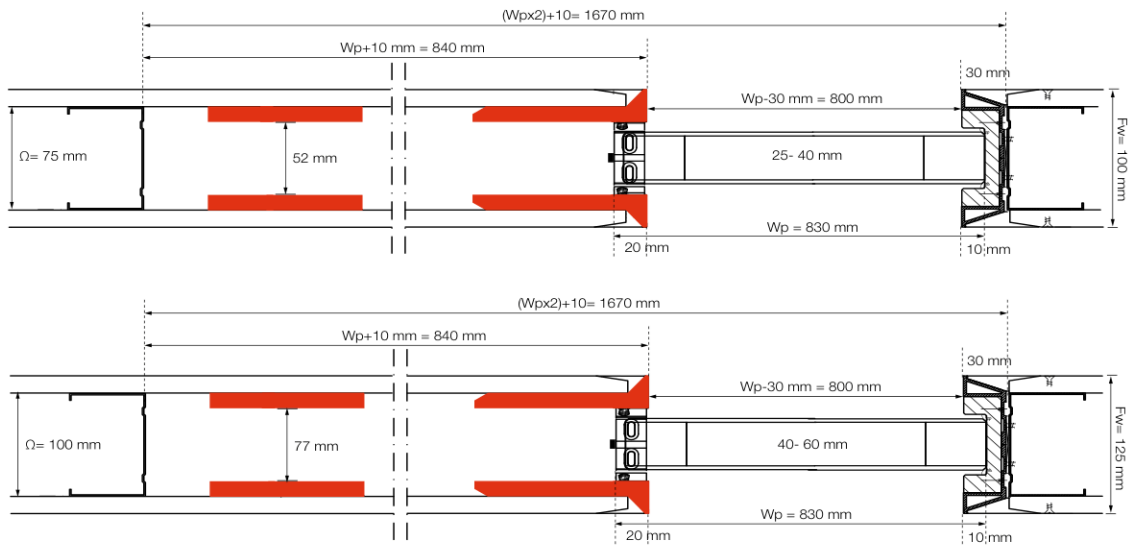

Max: 2315 x 1030 mm

X5D dubbele beplating/ double placage/ double plating/ Doppelte beplankung

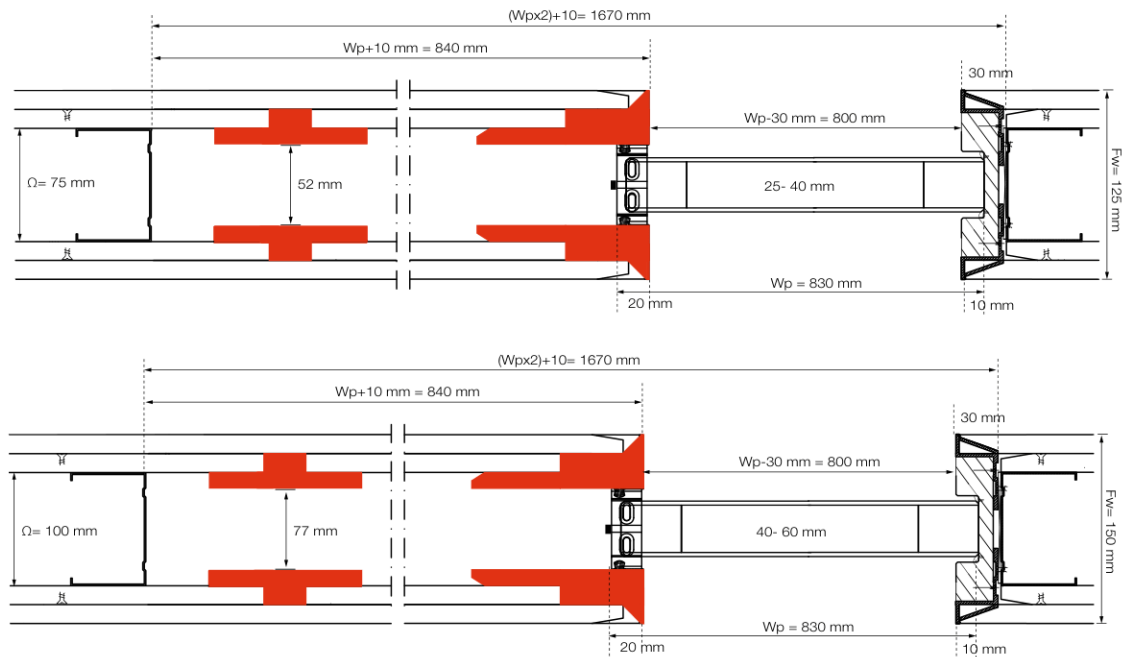

Max: 2315 x 1030 mm

Max: 3000 x 3030 mm

X5D32 dubbele beplating/ double placage/ double plating/ Doppelte beplankung

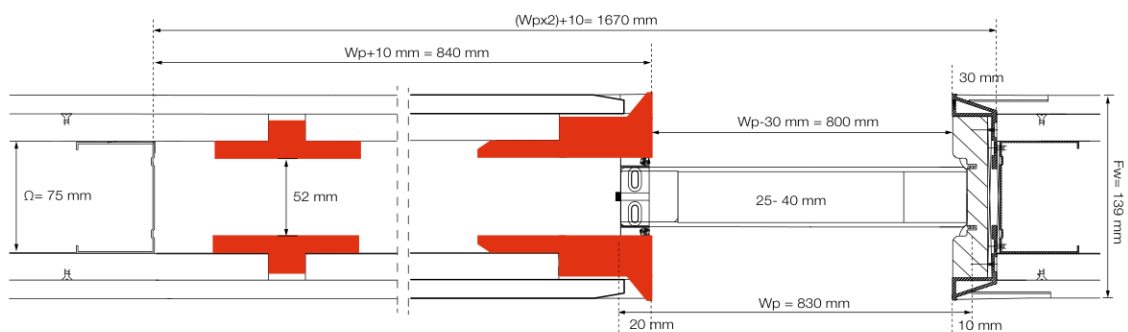

Max: 3000 x 1030 mm

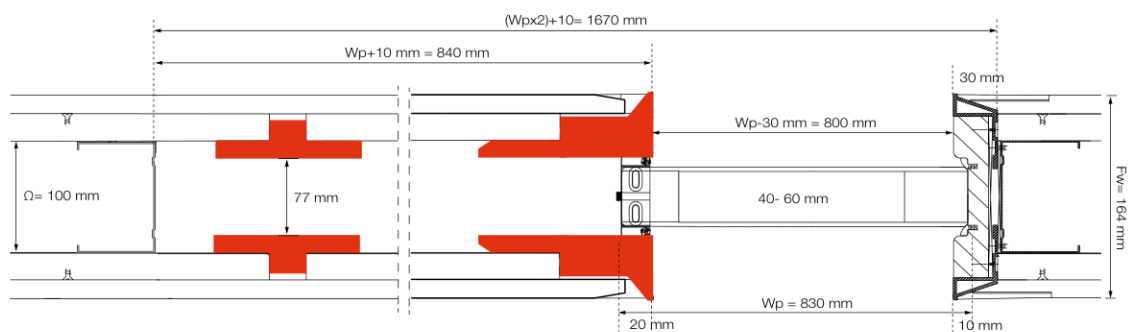

Max: 3500 x 3030 mm

X5D50

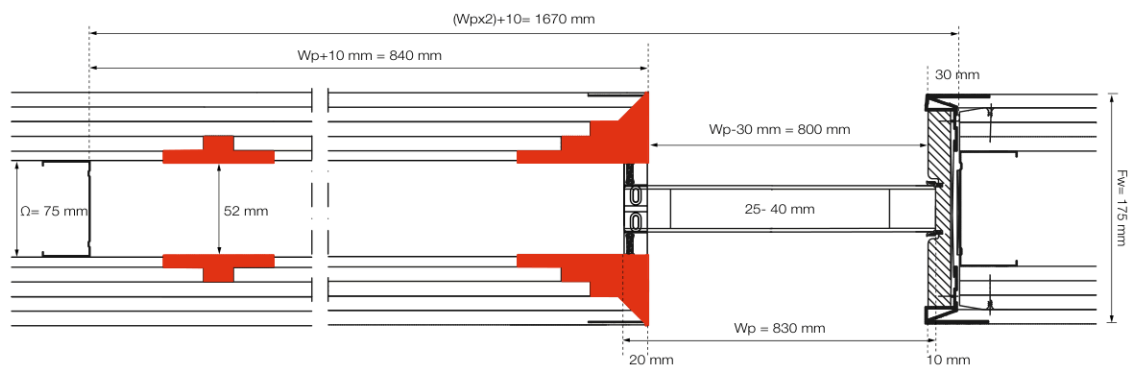

Max: 3000 x 1030 mm

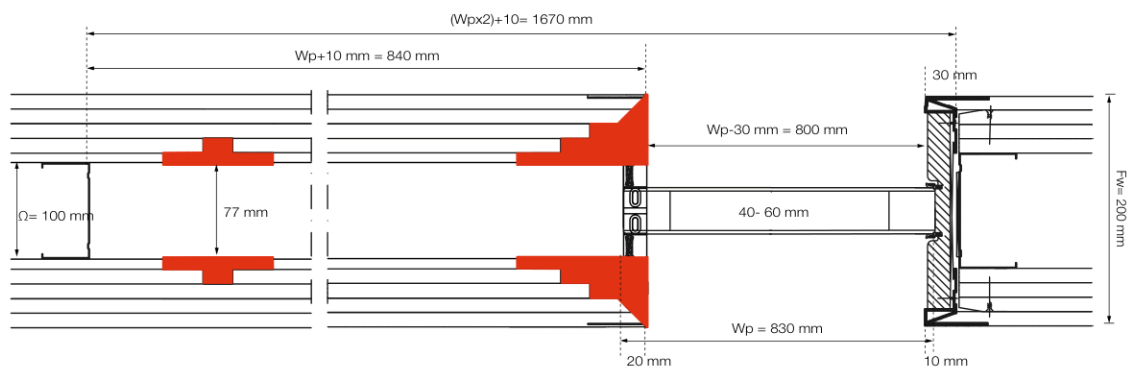

Max: 3500 x 3030 mm

WIDTH DOUBLE DOOR

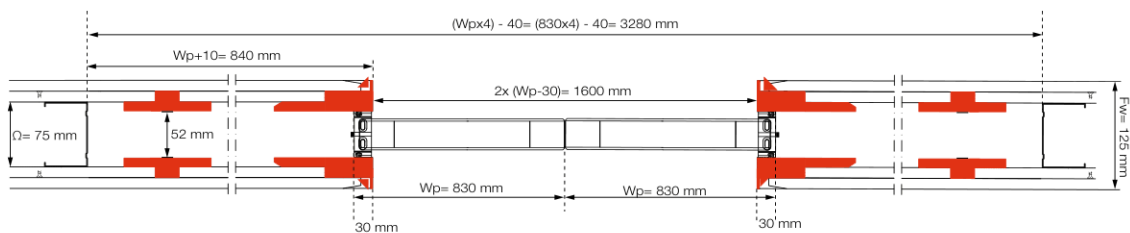

- | | |
|------------------------|---------------------------------|
| Wp: Deurbreedte | Fw: Afgewerkte muurdikte |
| Largeur de porte | Epaisseur de mur fini |
| Width door panel | Finished wall thickness |
| Türblatt breite | Fertigmass Mauerwerk |



X5 INSTALLATION SINGLE DOOR

01 CONSTRUCTION

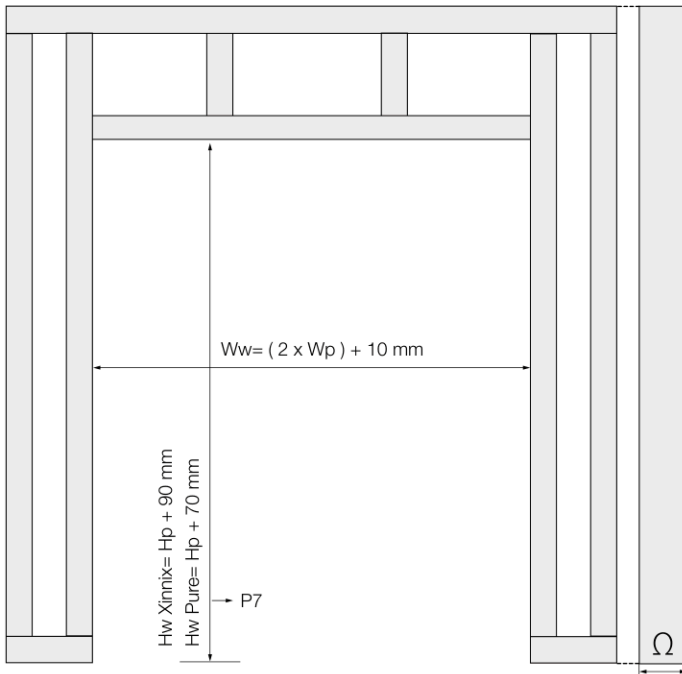

Ww: Breedte profielconstructie
 Largeur de la construction
 Width profile construction
 Konstruktion Profilbreite

Wp: Breedte deurblad
 Largeur panneau de porte
 Width door panel
 Breite Türblatt

Hw: Hoogte profielconstructie
 Hauteur de la construction
 Height profile construction
 Konstruktion Profilhöhe

Hp: Hoogte deurblad
 Hauteur panneau de porte
 Height door panel
 Höhe Türblatt

Ω : Profielbreedte
 Largeur du profil
 Profile width
 Profilbreite

02 BEAM

BOX 2

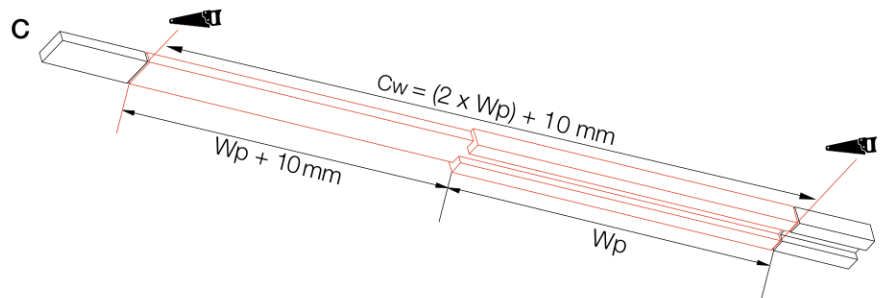
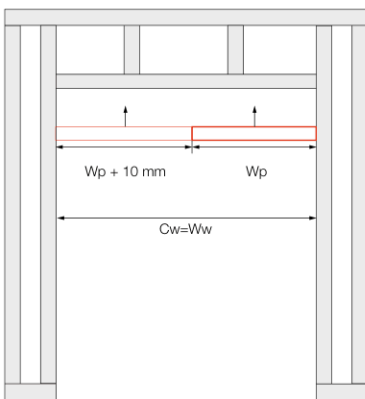

03 RAIL

BOX 2

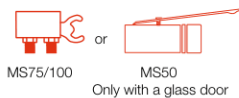
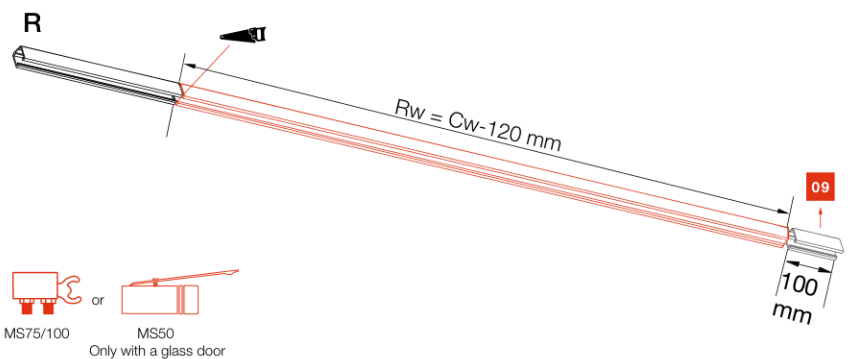
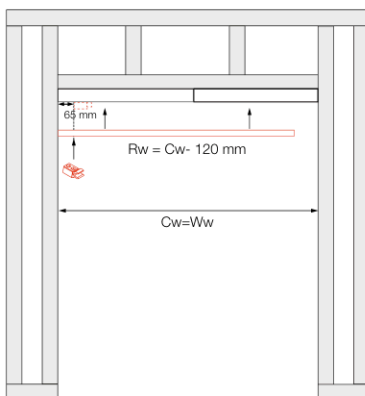



04 BASEPLATE

BOX 2

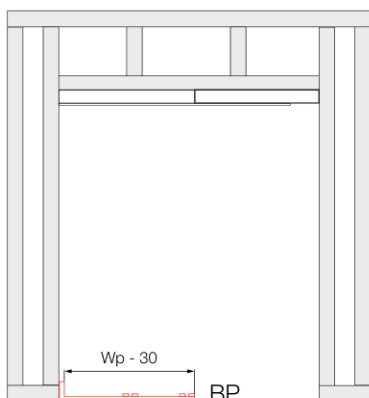

Wp= 830 mm → **BP= 800** (number indicated on the plate)
Wp= 930 mm → **BP= 900**
Wp= 1030 mm → **BP= 1000**

BP= Wp-30

Wp: Breedte deurblad
 Largeur panneau de porte
 Width door panel
 Breite Türblatt

05 UPRIGHTS

BOX 1

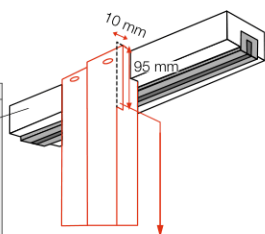
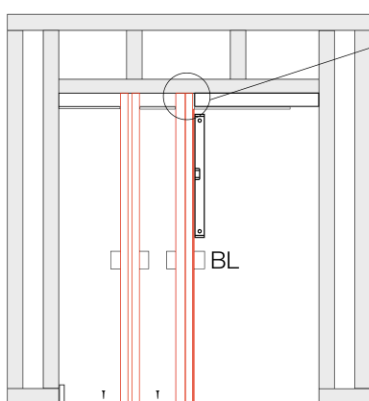

BAUALU FINISH
 Uitzagen op de werf
 Couper sur chantier
 To cut on site
 Sägen auf der Baustelle

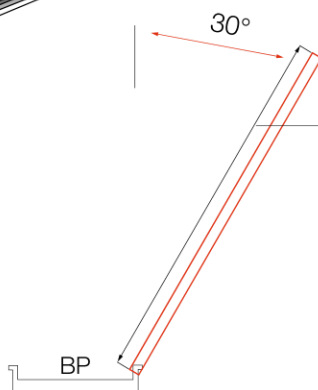

BAUALU finish
Uprights: Hp + 85 mm

Pure finish
Uprights: Hp + 65 mm

De frames zijn onderaan aanpasbaar op de werf.
 A couper en bas sur le chantier, si nécessaire.
 Adjustable at the bottom on the construction site if necessary.
 Unterseite abschneiden bauseitig wenn notwendig.

BOX 2 **BL:** Montageblokken/ blocs de styromousse/ styrofoam blocks/ Styropor Blöcke

06 BRUSHES

BOX 2

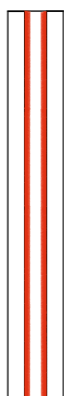

B

B= Borstels
 Brosses
 Brushes
 Bürsten

Ω 75= 5 mm
 Ω 100=19 mm

07 PLASTERBOARD

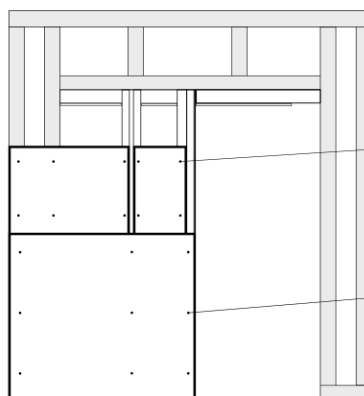

BOX 2

3,5 x 19 mm
 meegeleverd
 inclus
 included
 inbegrifen

3,5 x 25 mm
niet meegeleverd
non inclus
not included
nicht inbegrifen



08 SUSPENSION + INSTALLATION DOOR

BOX 2

BAUALU

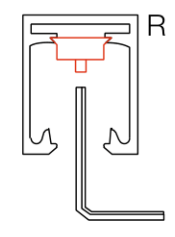
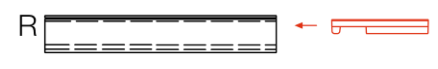
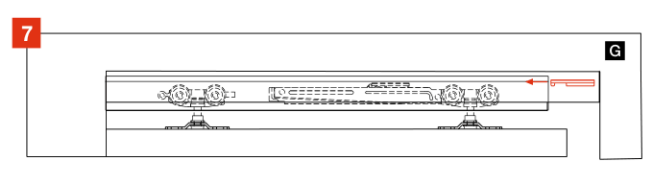
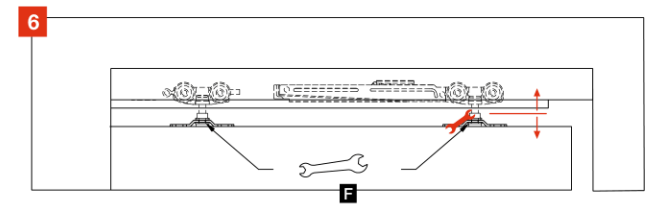
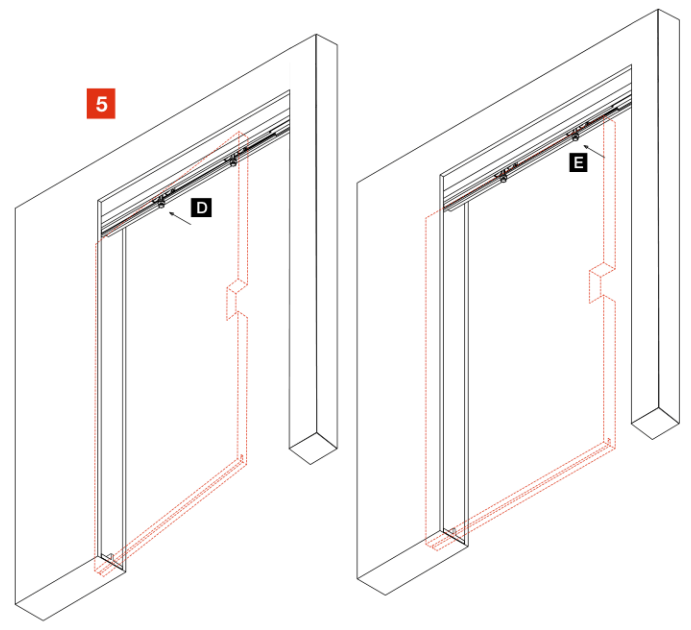
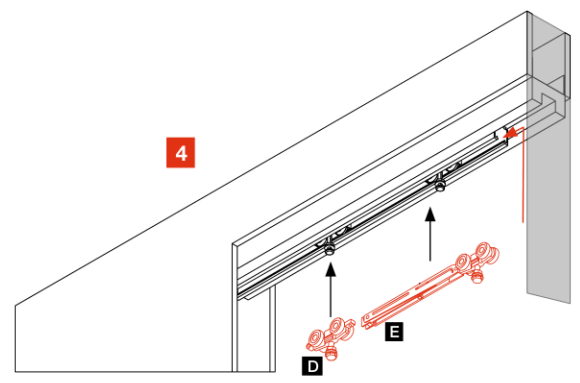
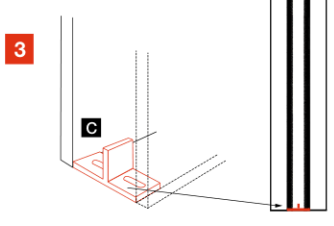
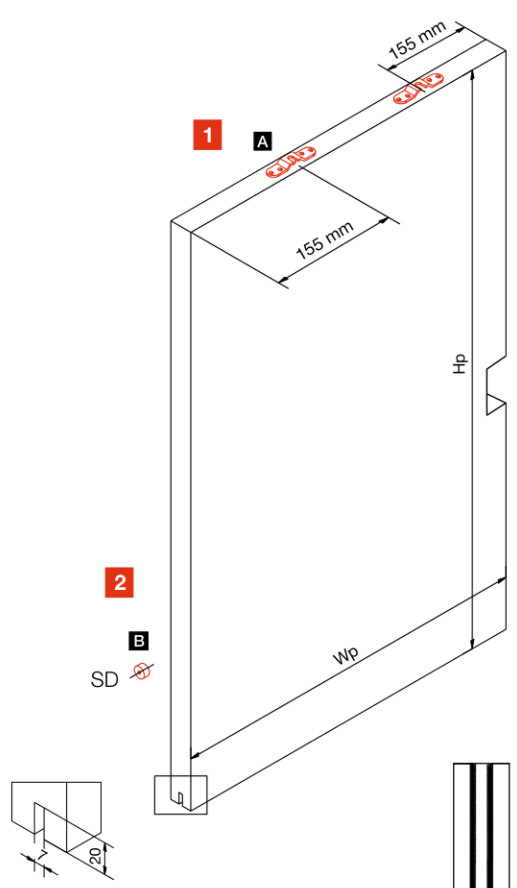
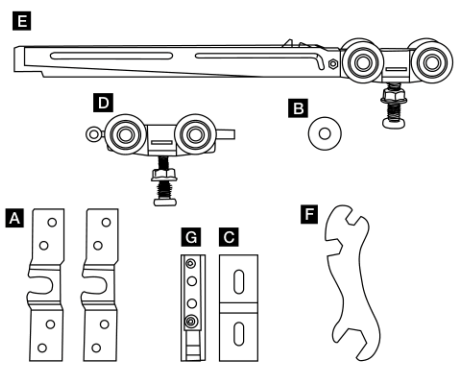



BOX 2

PURE

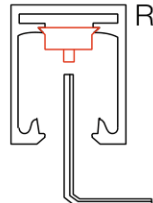
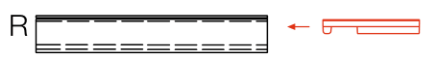
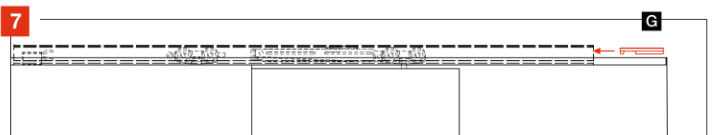
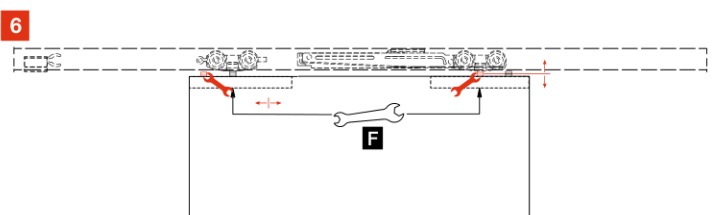
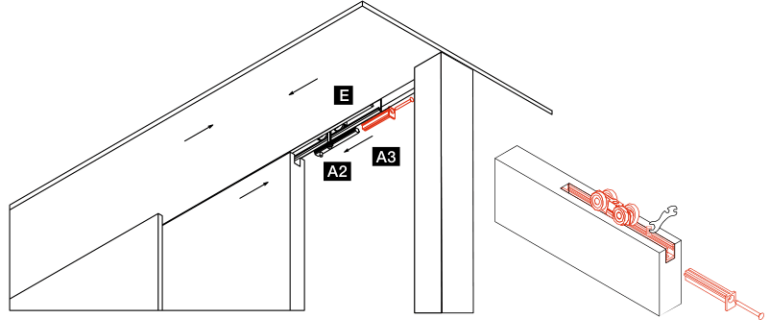
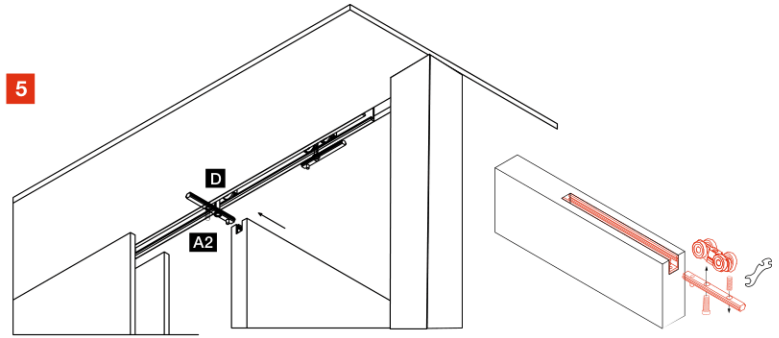
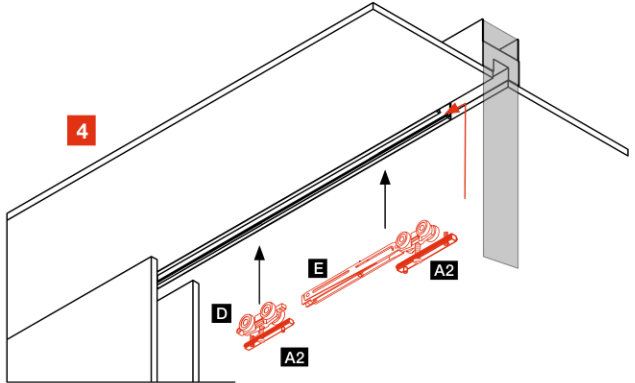
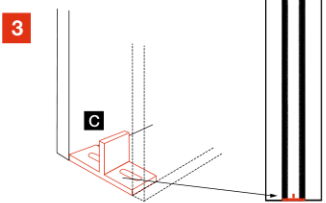
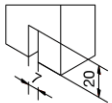
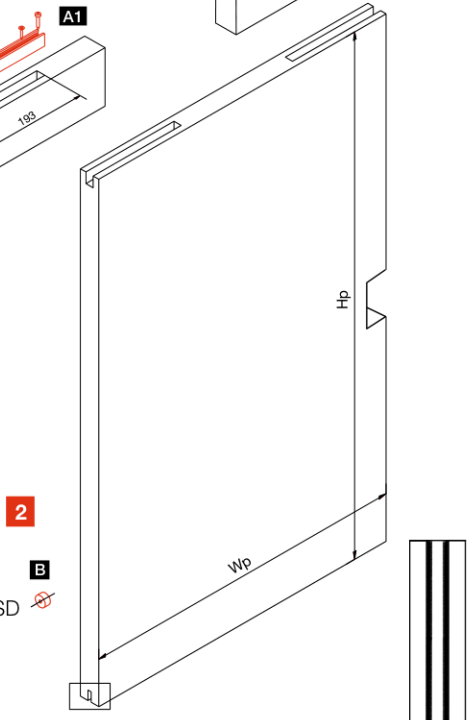
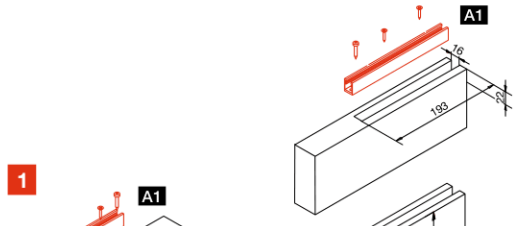
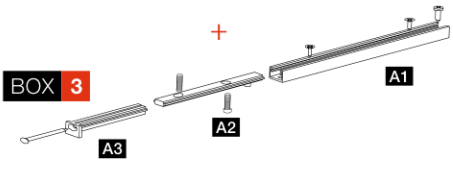
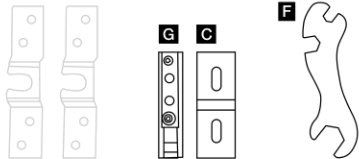
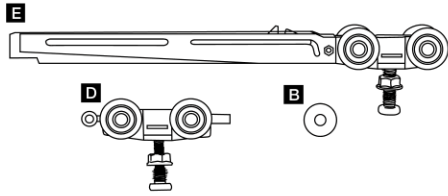



!!Volgende stappen pas uitvoeren na de installatie van de deur.
 !!Prochaines étapes seulement après l'installation de la porte.
 !!Next steps only after the door has been installed.
 !!Nächste Schritte erst nach dem Einbau der Tür.

09 CLOSING PROFILE + END PIECE RAIL

BOX 3

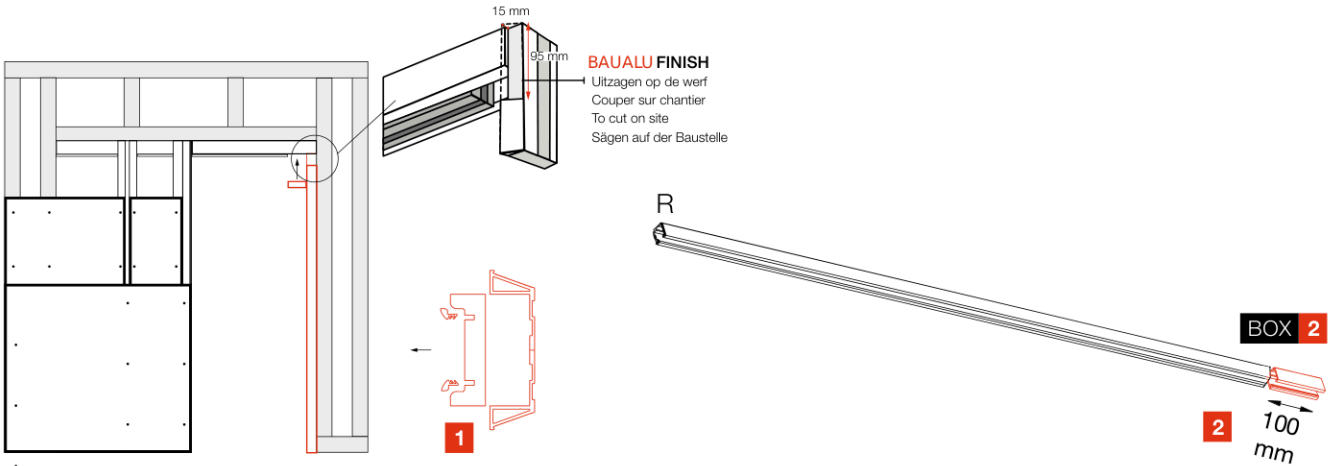

10 BAUALU FINISH

BOX 3

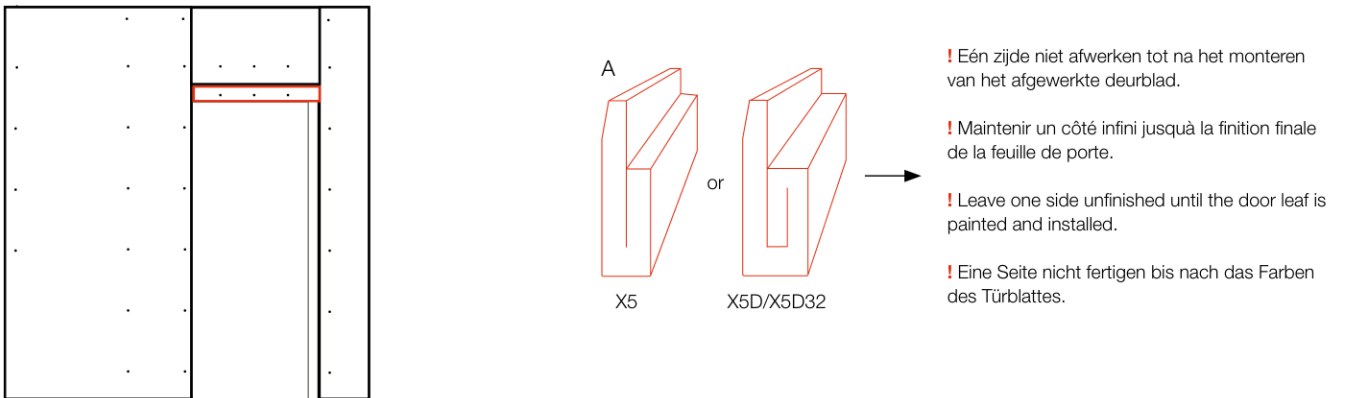



X5 INSTALLATION DOUBLE DOOR

01 CONSTRUCTION

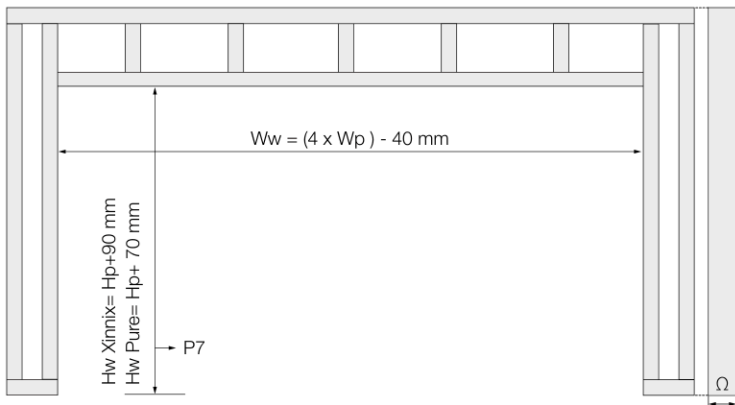

- Ww:** Breedte profielconstructie
Largeur de la construction
Width profile construction
Konstruktion profilbreite
- Hp:** Hoogte deurblad
Hauteur panneau de porte
Height door panel
Höhe Türblatt
- Wp:** Breedte deurblad
Largeur panneau de porte
Width door panel
Breite Türblatt
- Ω:** Profielbreedte
Largeur du profil
Profile width
Profilbreite
- Hw:** Hoogte profielconstructie
Hauteur de la construction
Height profile construction
Konstruktion Profilhöhe

02 BEAM + RAIL

BOX 2

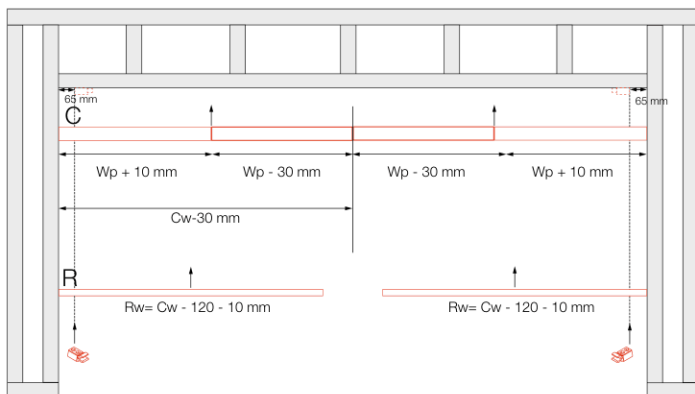

* Verwijder een extra 30 mm aan de brede zijde van de balk + verwijder een extra 10 mm van de rail (door afwezigheid van een slaglat bij dubbele deuren).

Enlever 30 mm supplémentaires sur le côté large de la traverse + enlever 10 mm supplémentaires du rail (en raison de l'absence d' un latte battant sur les doubles portes).

Remove an additional 30 mm on the wide side of the beam + remove an additional 10 mm of the rail (due to the absence of a closing profile with double doors).

Zusätzliche 30 mm an der breiten Seite des Balkens entfernen + zusätzliche 10 mm an der rail (wegen des Fehlens einer Abschlussprofil bei Doppeltüren).

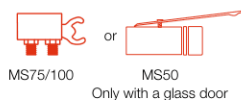
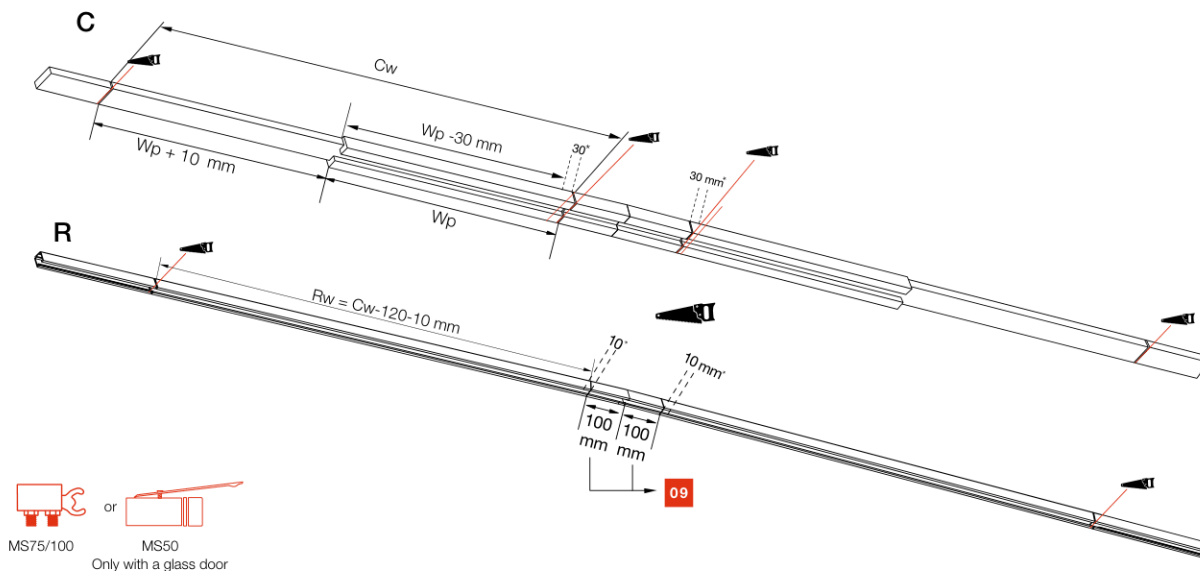



04 BASEPLATE

BOX 2

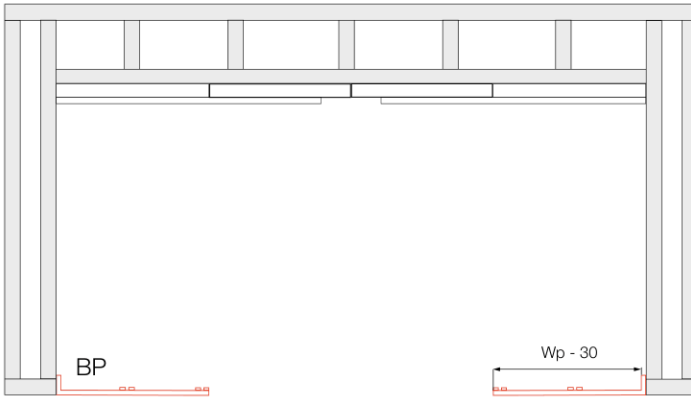

Wp = 830 mm **BP** = 800 (number indicated on the plate)
Wp = 930 mm **BP** = 900
Wp = 1030 mm **BP** = 1000

BP = Wp - 30

Wp: Breedte deurblad
 Largeur panneau de porte
 Width door panel
 Breite Türblatt

05 UPRIGHTS

See page 11

06 BRUSHES

See page 11

07 PLASTERBOARD

See page 11

08 SUSPENSION + INSTALLATION DOOR

See page 14

09 END PIECE RAIL

BOX 2

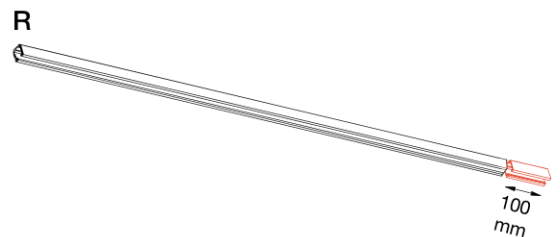
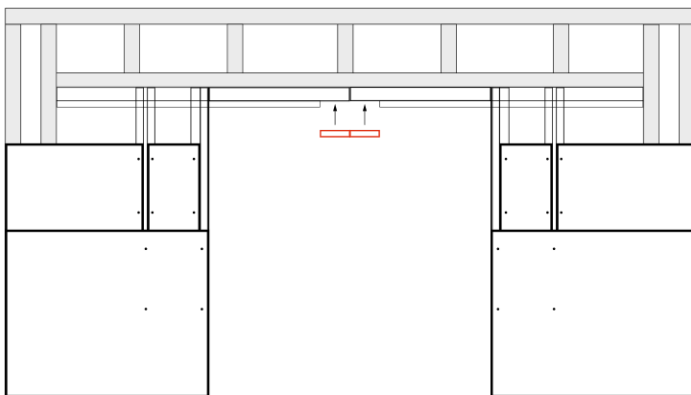

10 BAUALU FINISH

See page 14



X5 INSTALLATION GLASS DOOR

01 CONSTRUCTION

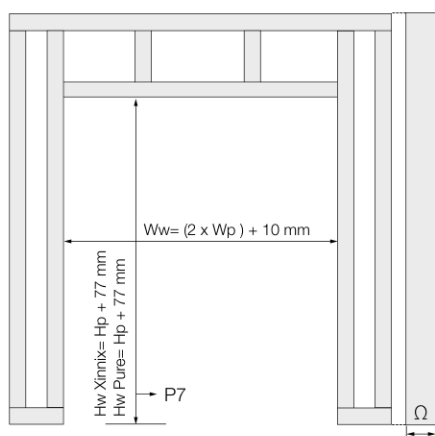

Ww: Breedte profielconstructie
 Largeur de la construction
 Width profile construction
 Konstruktion Profilbreite

Hp: Hoogte deurblad
 Hauteur panneau de porte
 Height door panel
 Höhe Türblatt

Wp: Breedte deurblad
 Largeur panneau de porte
 Width door panel
 Breite Türblatt

Ω: Profielbreedte
 Largeur du profil
 Profile width
 Profilbreite

Hw: Hoogte profielconstructie
 Hauteur de la construction
 Height profile construction
 Konstruktion Profilhöhe

02 BEAM

See page 10

03 RAIL

See page 10

04 BASEPLATE

See page 11

05 UPRIGHTS

BOX 1

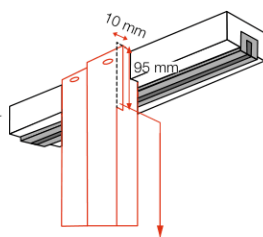
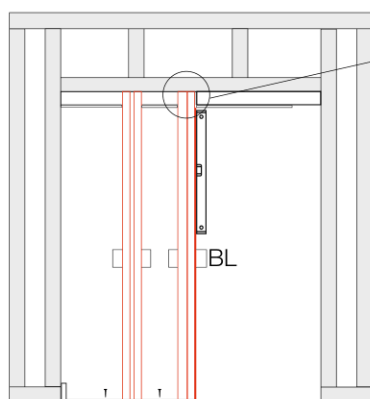

BAUALU FINISH
 Uitzagen op de werf
 Couper sur chantier
 To cut on site
 Sägen auf der Baustelle

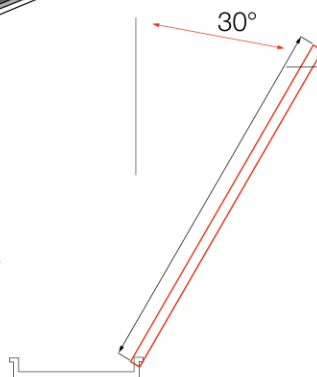

Overall length
Uprights: Hp + 72 mm

De frames zijn onderaan aanpasbaar op de werf.
 A couper en bas sur le chantier, si nécessaire.
 Adjustable at the bottom on the construction site if necessary.
 Unterseite abschneiden bauseitig wenn notwendig.

BOX 2 **BL** = Montageblokken/ blocs de styromousse/ styrofoam blocks/ Styropor Blöcke

06 BRUSHES

See page 11

07 PLASTERBOARD

See page 11



08 SUSPENSION + INSTALLATION DOOR

BOX 2

MS50

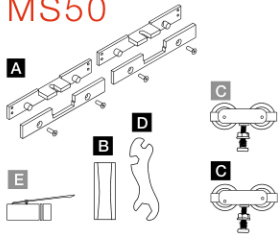

MS75

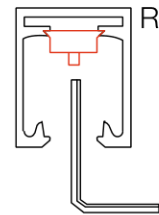
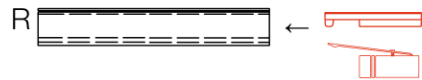
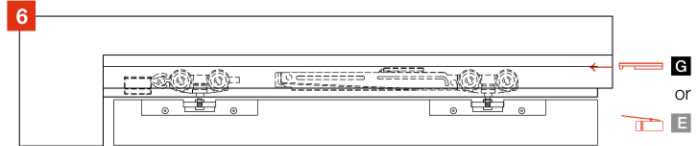
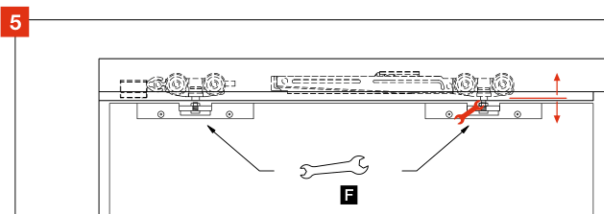
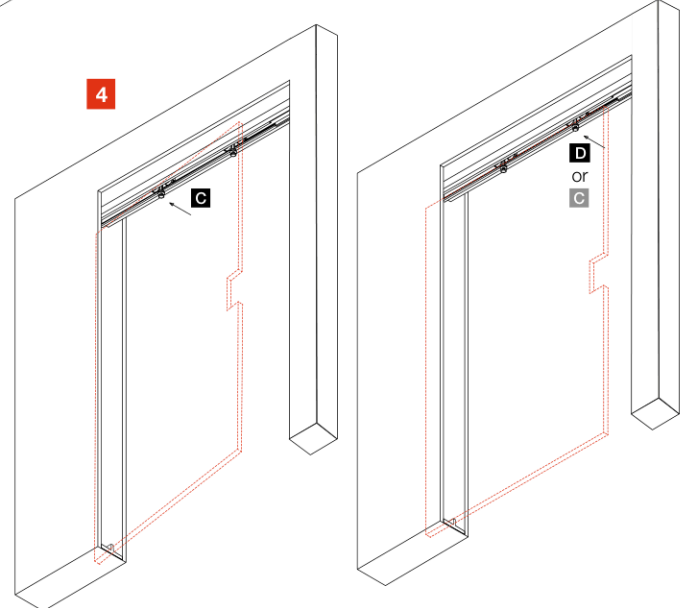
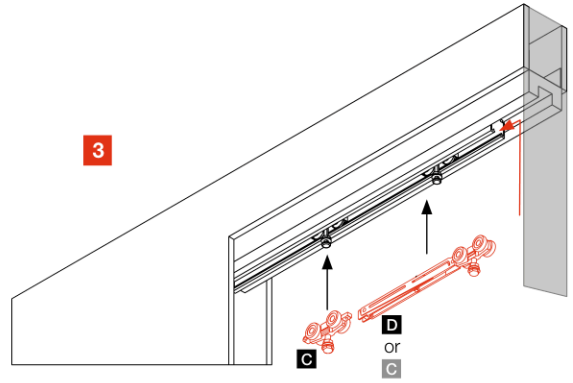
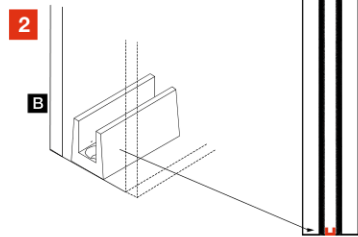
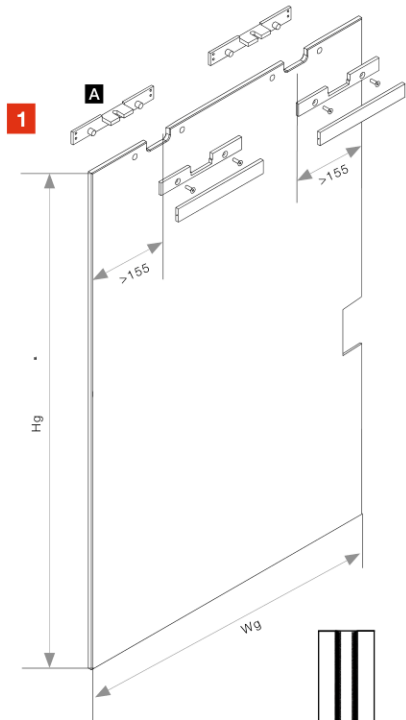
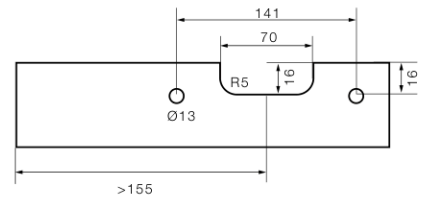
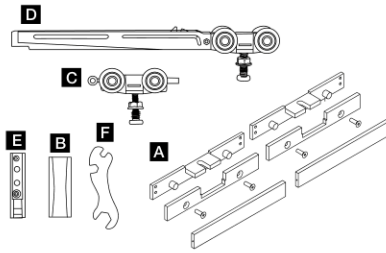



09 CLOSING PROFILE + END PIECE RAIL

BOX 3

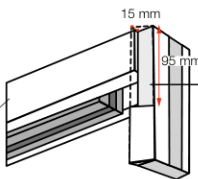
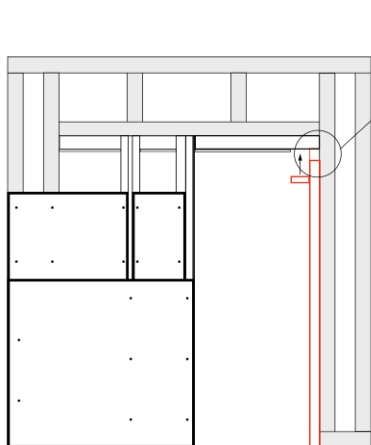

BAUALU FINISH
Uitzagen op de werf
Couper sur chantier
To cut on site
Sägen auf der Baustelle

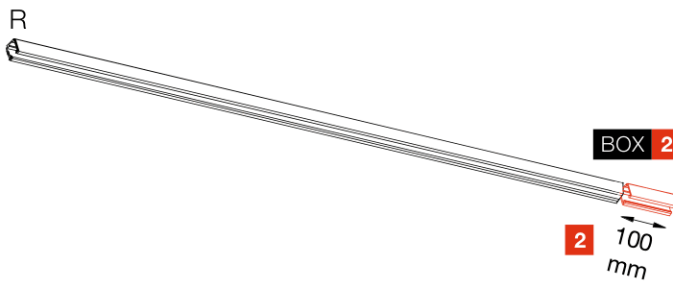
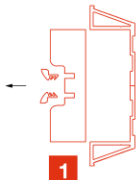

BOX 2

2 100 mm



BOXCONTENT WALL

BOX 1 WALL

Standers/ montants/ uprights/ Pfosten

X5

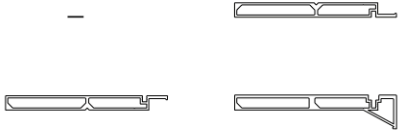

X5-WALL2115

X5-WALL2415

X5D

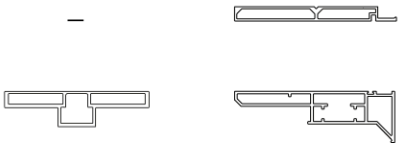

X5D-WALL2415

X5D-WALL2715

X5D-WALL3015

X5D32

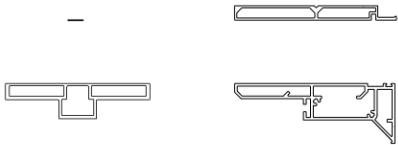

X5D32-WALL2415

X5D32-WALL2715

X5D32-WALL3015

X5D32-WALL3515

X5D50

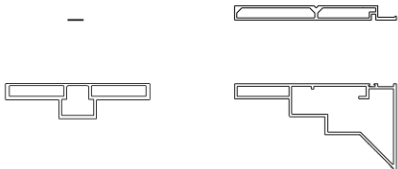

X5D50-WALL2415

X5D50-WALL2715

X5D50-WALL3015

X5D50-WALL3515

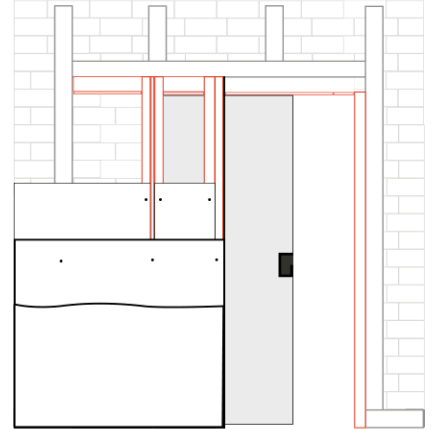

Dubbele schuifdeur 2x BOX 1
Porte coulissante double 2x BOX 1
Double sliding door 2x BOX1
Doppel-Schiebetür 2x BOX 1

CODE	X5	X5D	X5D32	X5D50	Xinnix Hp*	Pure Hp*	Glass Hp*
...-2115	x				2115	2135	2130
...-2415		x	x	x	2415	2435	2430
...-2715		x	x	x	2715	2735	2730
...-3015		x	x	x	3015	3035	3030
...-3515			x	x	3515	3535	3530

BOX 2 DOOR WIDTH

See page 5

*Hp: Hoogte deurblad
Hauteur panneau de porte
Height door panel
Höhe Türblatt

BOX 3 FINISH

See page 6

20 BAUALU



X5WALL DIMENSIONS

HEIGHT X5 WALL

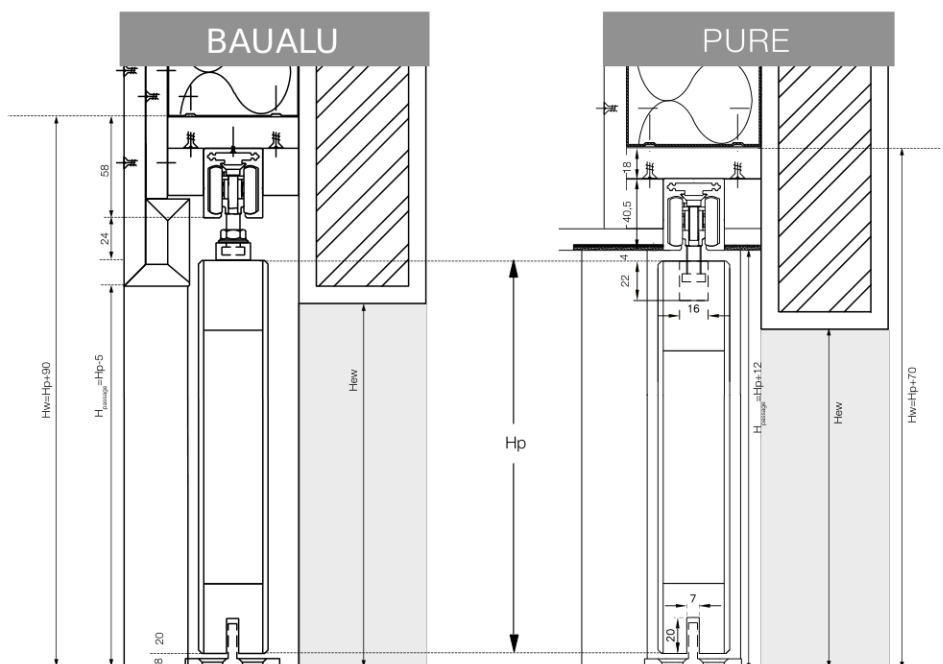

Hw: Hoogte profielconstructie
Hauteur de la construction
Height profile construction
Konstruktion Profilhöhe

Hp: Hoogte deurblad
Hauteur panneau de porte
Height door panel
Höhe Türblatt

Hew: Hoogte bestaande opening
Hauteur mur existant
Height existing wall
Höhe Mauer loch

$Hew + 10 \text{ mm} = \text{min. } Hp$

WIDTH X5 WALL

X5D dubbele beplating/ double placage/ double plating/ Doppelte beplankung

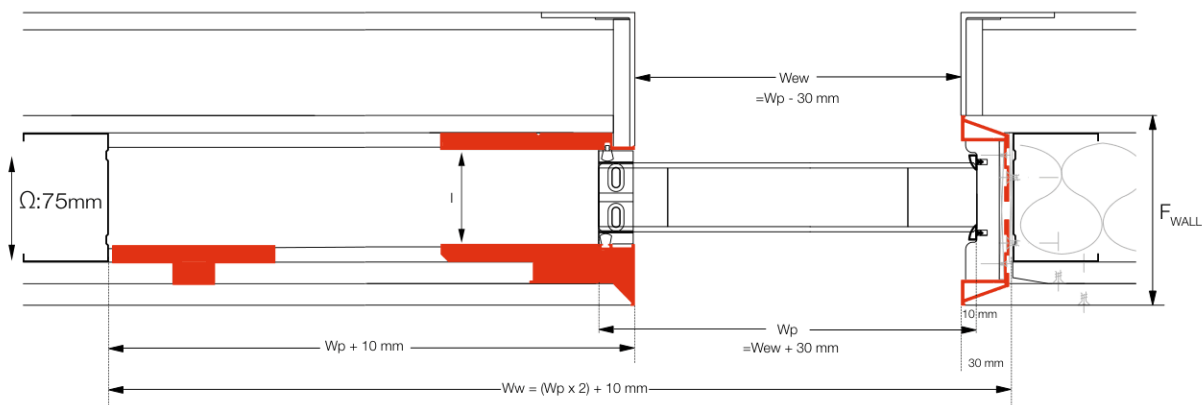

X5 WALL		X5D WALL		X5D32 WALL		X5D50 WALL	
Enkele beplating/ simple placage/ single plating/ Einfach beplankung		Dubbele beplating/ double placage/ double plating/ Doppelte beplankung		Dubbele beplating/ double placage/ double plating/ Doppelte beplankung		Dubbele beplating/ double placage/ double plating/ Doppelte beplankung	
MS 75	MS 100	MS 75	MS 100	MS 75	MS 100	MS 75	MS 100
$F_{\text{WALL}} : 87,5 \text{ mm}$	$F_{\text{WALL}} : 112,5 \text{ mm}$	$F_{\text{WALL}} : 100 \text{ mm}$	$F_{\text{WALL}} : 125 \text{ mm}$	$F_{\text{WALL}} : 105,5 \text{ mm}$	$F_{\text{WALL}} : 130,5 \text{ mm}$	$F_{\text{WALL}} : 125 \text{ mm}$	$F_{\text{WALL}} : 150 \text{ mm}$
$l : 52 \text{ mm}$	$l : 77 \text{ mm}$	$l : 52 \text{ mm}$	$l : 77 \text{ mm}$	$l : 52 \text{ mm}$	$l : 77 \text{ mm}$	$l : 52 \text{ mm}$	$l : 77 \text{ mm}$

Wp: Deurbreedte
Epaisseur de porte
Width door panel
Türblatt breite

Wew: Breedte bestaande opening
Largeur mur existant
Width existing wall
Breite Mauer loch

F_{WALL} : Totale dikte voorzetwand
Epaisseur totale du mur en applique
Total thickness extra wall
Fertigmass extra wand



X5WALL INSTALLATION SINGLE DOOR

01 CONSTRUCTION

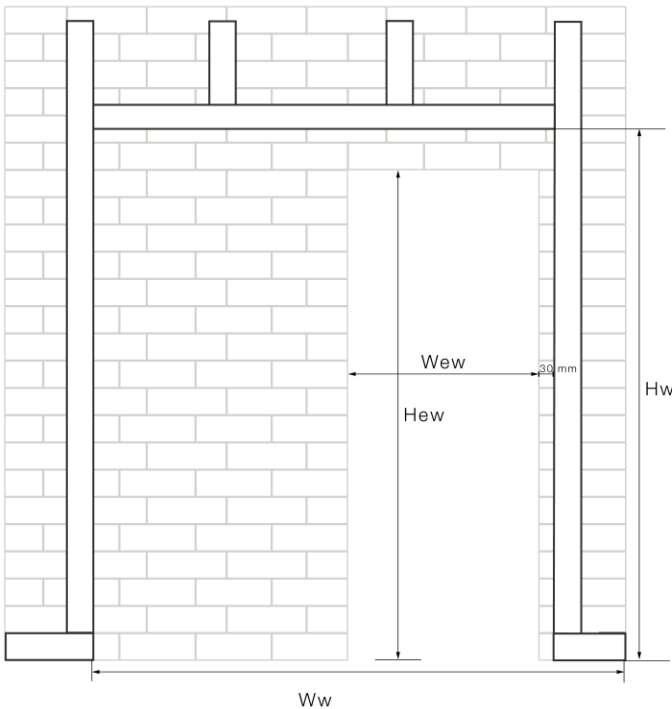

$$H_p \text{ min.} = H_{ew} + 10 \text{ mm}$$

$$W_p = W_{ew} + 30 \text{ mm}$$

$$H_w \text{ Xinnix} = H_p + 90 \text{ mm}$$

$$H_w \text{ Pure} = H_p + 70 \text{ mm}$$

$$W_w = (W_p \times 2) + 10 \text{ mm}$$

Wp: Deurbreedte
Epaisseur de porte
Width door panel
Türblatt breite

Hw: Hoogte profielconstructie
Hauteur de la construction
Height profile construction
Konstruktion Profilhöhe

Wew: Breedte bestaande opening
Largeur mur existant
Width existing wall
Breite Mauer Türöffnung

Hp: Hoogte deurblad
Hauteur panneau de porte
Height door panel
Höhe Türblatt

Hew: Hoogte bestaande opening
Hauteur mur existant
Height existing wall
Höhe Mauer Türöffnung

!!Voor de andere installatie stappen zie pagina 10.
!!Prochaines étapes d'installation voir page 10.
!!Other installation steps see page 10.
!!Weitere Installationsschritte siehe Seite 10.

09 CLOSING PROFILE + END PIECE RAIL

BOX 3

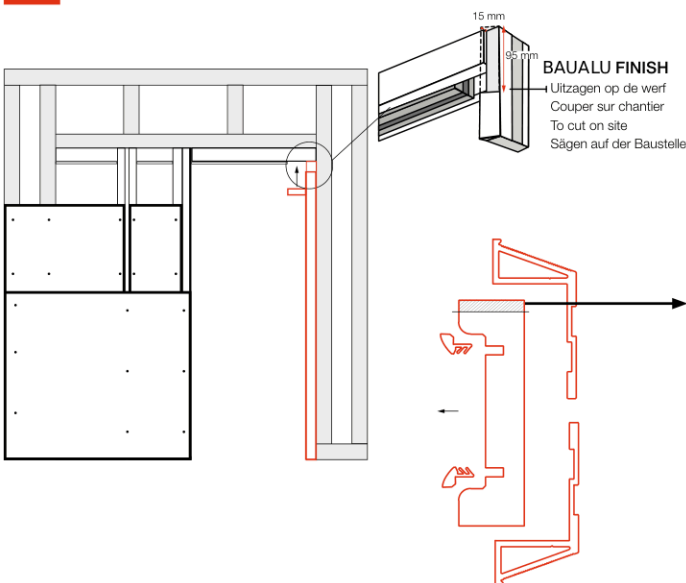

Slaglat al dan niet aanpassen afhankelijk van de situatie op de werf.

Ajustez ou non le listel en fonction de la situation sur le chantier.

Adjust the closing profile or not depending on the situation on the construction site.

Seitlich zuschneiden auf der Baustelle wenn notwendig.

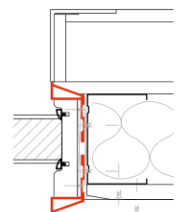

See page 14



X5 HARDWARE

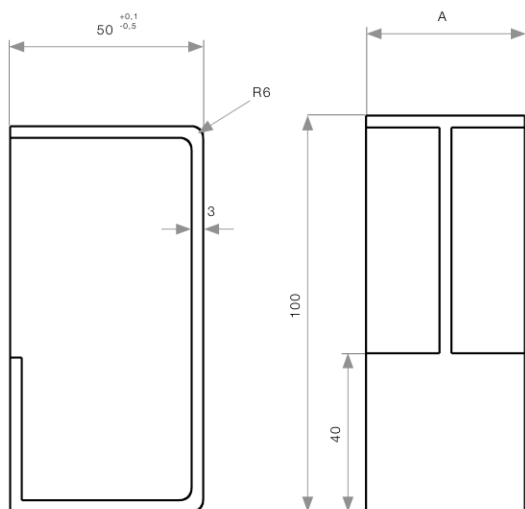

CODE	A
X3310	10
X3335	35
X3340	40
X3345	45
X3350	50

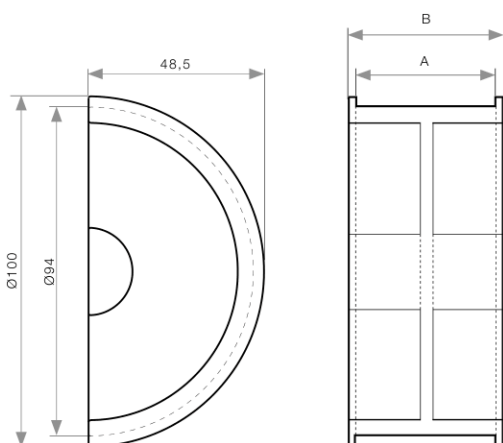

CODE	A	B
X3010	10	14
X3012	12	16
X3035	35	39
X3040	40	44
X3045	45	49
X3050	50	54
X3060	60	64

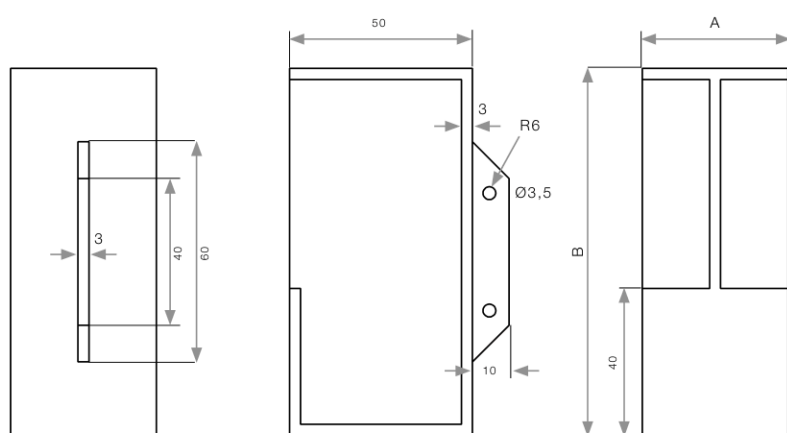

CODE	A	B
X3723	40	100
X3739	50	100
X3738	40	500

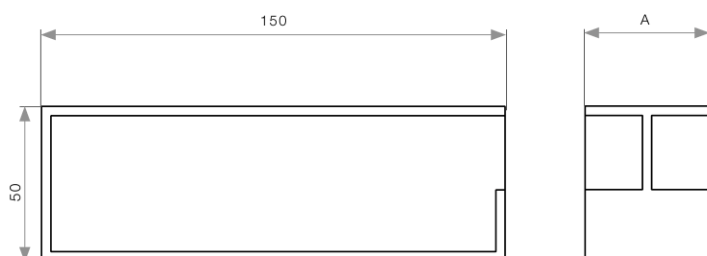

CODE	A
X3772	40
X3778	50

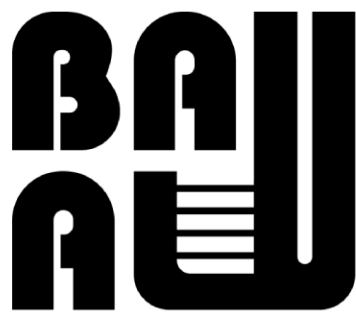

www.BAUALU.com